

# RAMMER R18P



PERFORMANCE LINE

VIBRATION AND SOUND SUPPRESSED

IDLE BLOW PROTECTION (FIELD ADJUSTABLE ON/OFF)

RAMLUBE II GREASING SYSTEM

RAMDATA II SERVICE INDICATOR

EXCELLENT POWER-TO-WEIGHT RATIO

NITROGEN PISTON ACCUMULATOR

PRESSURE DAMPENING MEMBRANE ACCUMULATOR

QUICK CHANGE TOOL SYSTEM

EASY TO SERVICE



## UNBEATABLE PERFORMANCE

The new Rammer Performance Line hammers are your everyday solution for a wide range of breaking demands. Designed with proven Rammer features and standards, these Rammer Performance Line hammers offer more than just excellent power-to-weight ratio, they bring the quality reassurance that only a true Rammer hammer can bring.

Read more about the product from [www.rammer.com](http://www.rammer.com)



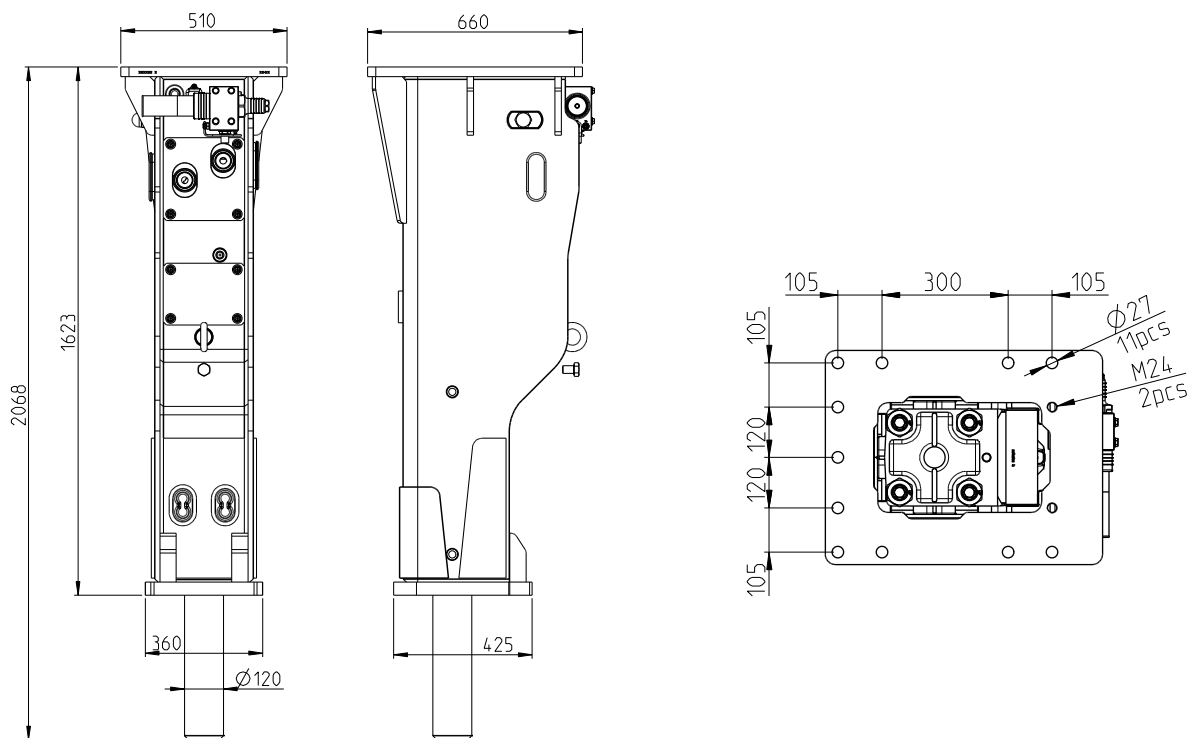

## ACCESSORIES



### Ramlube II

Lubrication system for optimum wear and impact protection.



### Ramdata II

Gives information about service interval status, service history and accumulated working history.

Minimum working weight, kg	1240
Impact rate, bpm	280–760
Operating pressure, bar	160–180
Pressure relief, min bar	200
Pressure relief, max bar	220
Oil flow range, l/min	100–140
Back pressure, max bar	10
Input power, kW	42
Tool diameter, mm	120
Carrier weight, allowed range, t	15–23
Noise level, measured sound power level, LWA, dB	119
Noise level, guaranteed sound power level, LWA, dB	123

## TOOLS

Moil point tool



Standard chisel tool



Customized special tool



Blunt tool



Super blunt tool



Pyramid tool

